

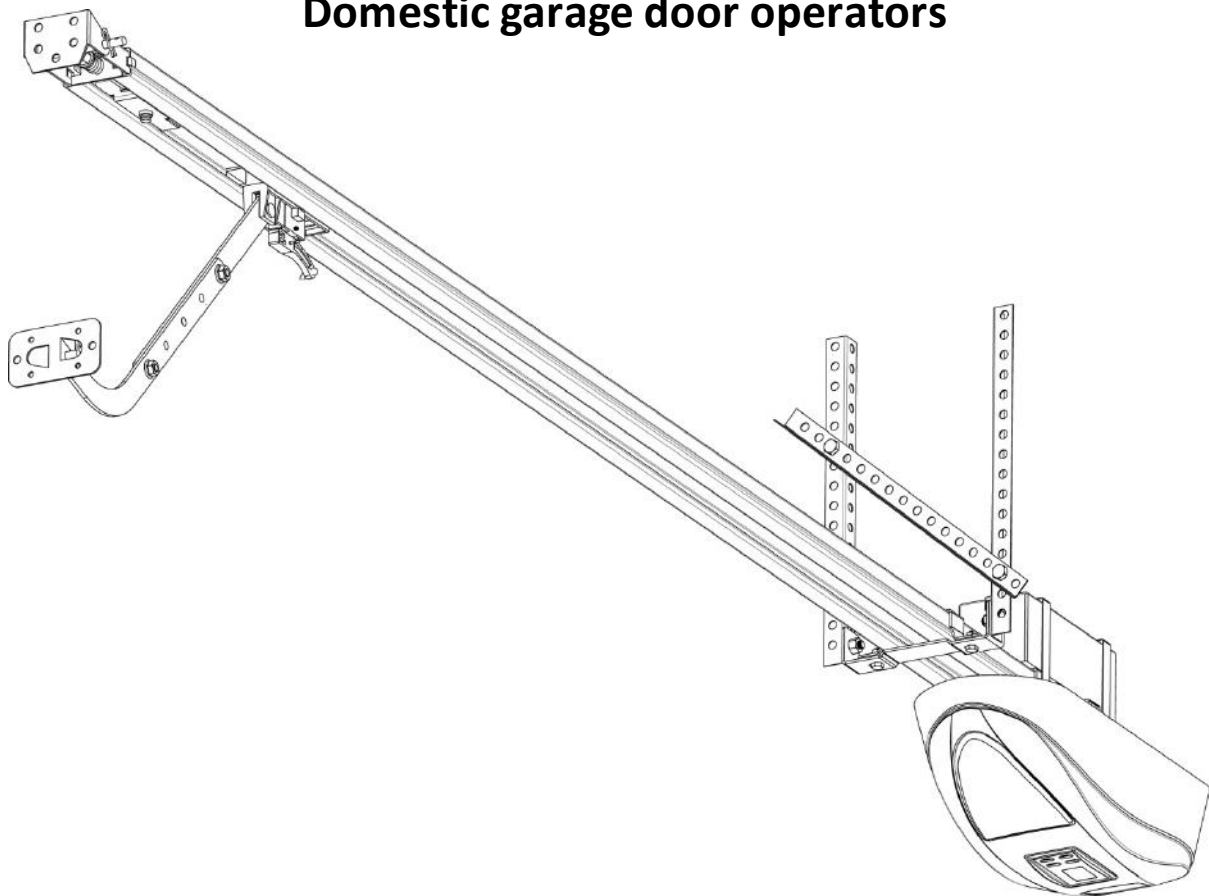

Domestic garage door operators



Installer Instructions

TABLE OF CONTENTS	
Page	Category
Introduction	
3	Safety obligations and general warnings.
4	Technical specifications.
5	Component identification and descriptions.
Hardware installation	
6	Installing the clutch release mechanism on the sledge/traveller.
7	Sectional overhead door – Installing the wall mount bracket.
7	Sectional overhead door – Installing the drawbar and hanging straps.
8	Sectional overhead door – Installing the door mount bracket.
8	Sectional overhead door – Installing the link arm.
8	Sectional overhead door – Testing the mechanical drive and linkage.
9	Trackless tip-up door – Installing the wall mount bracket.
10	Trackless tip-up door – Installing the door mount bracket.
10	Trackless tip-up door – Installing the link arm and hanging straps.
10	Trackless tip-up door – Testing the mechanical drive and linkage.
11	Both door types – Attaching the motor-head to the drawbar.
11	Both door types – Attaching the battery to the drawbar.
11	Both door types – Supplying household mains power to the motor-head.
Control card wiring and setup	
12	Wiring of optional extra devices to the system.
13	Control panel dashboard and programming menu summary. (How to navigate the menu)
14	Programming - Open and closed limit setup and door load profiling.
15	Programming - Setting the obstruction force sensing, safety level.
16	Programming - Activating safety beam mode.
17	Programming - Activating and selecting the auto-close time.
18	Programming - Selecting an electric lock mode.
Receiver programming	
19	Learning a new transmitter button code into the receiver memory.
20	Clearing a single transmitter button code from the receiver memory.
21	Master erasing all transmitter button codes from the receiver memory.
22	Quick method of learning a transmitter button code into the memory without entering the programming menu.
Operating	
23	Basic operating features using the (BT) button triggers.
25	Advanced operating features - Party mode.
26	Advanced operating features - Holiday lock-out mode.
27	Advanced operating features - Strike lock mode.
28	Advanced operating features - Magnetic lock mode.
29	Advanced operating features - Auto-close example.
29	Advanced features - Safety beam example.
30	Advanced features - Courtesy light operation.
Troubleshooting	
31	Buzzer, courtesy light and display warnings.
Warranty and declaration of conformity	
32	Warranty terms and conditions.

Be Safe!

General safety obligations and warning to the installers and users of ET Systems automation equipment. This document along with all user instructions must be issued to the responsible end user during the handover and instruction meeting.

1. Only suitably qualified persons, may install, repair or service the product. Unless expressly indicated in the user instructions, no user serviceable components can be found inside any ET Systems automation product.
2. It is important for personal safety to study and follow all the instructions carefully. Incorrect installation or misuse may cause serious personal harm.
3. Keep the instructions in a safe place for future reference.
4. This product was designed and manufactured strictly for the use indicated in the accompanying documentation. Any other use not expressly indicated in the documentation may damage the product and/or be a source of danger. ET Systems cannot accept responsibility for improper use or incorrect installation of this product.
5. ET Systems cannot accept responsibility if the principles of good workmanship are disregarded by the installer.
6. ET Systems cannot accept responsibility regarding safety and correct operation of the automation, if other manufacturer's equipment is added to this product.
7. Do not make any modifications or alterations to this product.
8. Anything other than expressly provided for in the accompanying instructions is not permitted.

Prior To Installation:

1. All unnecessary ropes, chains and fasteners must be removed and all unnecessary latches or locks must be disabled from locking.
2. The gate or door must be balanced correctly where it, neither opens nor closes from any position under its own load. When operated by hand the gate or door should be free of hindrance and easily moved. In the case of a garage door if the balancing springs need to be adjusted the adjustment should only be carried out by a qualified and experienced person.
3. The construction of the gate or door must be sound and automatable. It is the responsibility of the installer to ensure that the mechanical components of the gate or door system are sufficient to withstand the necessary forces in cases of overload.
4. It is the responsibility of the installer to ensure the gate or door is sufficiently trapped within its range of travel by means of mechanical end of travel stoppers.
5. Ensure all fixed mounting points such as the wall above the door, in a garage door system, are sound and strong enough to allow proper fixing of the operator.
6. It is the responsibility of the installer, to ensure the installed position selected for this product falls within the limitations of the product's ingress protection rating. (IP rating)
7. Ensure the area of installation is not subject to explosive hazards. There should be no volatile gasses or fumes as these can present a serious safety hazard.
8. All ET Systems garage door operators are supplied with a sealed 15A safety plug on lead for use in an electrical code of practice approved plug point. Do not extend, modify or replace the plug lead unless duly qualified as an electrician. Before installing the unit, ensure the mains supply is switched off.
9. ET Systems gate operators are supplied with a terminal connection for the electrical supply beneath the screwed down cover of the operator. In the case of a model requiring 220Vac supply at the operator an all pole negatively biased switch, with a contact opening of greater than 3mm, must be installed within 1,5m of the operator. This switch must be clear of all workings of the system and must be in a position secure from public access. This switch and its connections must be inspected and passed by a certified electrician prior to using it.
10. It is the responsibility of the installer to ascertain that the designated persons (including children) intended to use the system, do not suffer reduced physical sensory or mental capabilities, or lack of experience and knowledge, unless they have been given supervision or instruction concerning the use of the system by a person responsible for their safety.
11. The drive may not be installed on a door or gate incorporating a wicket door, unless the drive is disabled by the release of the wicket door. (Wicket door :- A pedestrian door within the main gate or door)

Installation:

1. Ensure the working area is clear of obstructions and obstacles.
2. Install the safety warning sticker within clear view of where the gate or door will be operated from. Typically this would be adjacent to any fixed trigger switches or on the gate or door itself.
3. The emergency release cord in a garage door automation system must be installed where it is no higher than 1.8m from the floor level.

4. Any additional fixed door control switches such as wall consoles or keypads, if installed, must be at a height of at least 1,5m, within clear sight of the gate or door and away from any moving components of the system.
5. Do not substitute any component of product with any other manufacturer's part. ET Systems accepts no responsibility for the safety and correct operation of the automation system in this circumstance.
6. It is highly recommended that a set of safety infra-red beams be used in conjunction with this product. The safety beams must be installed in such a way that the product is prevented from running when anything is in the path of the door or gate.
7. Over and above the recommendation to use safety infra-red beams with this product it is mandatory to install and use a safety beam set when using the automatic closing feature. It is recommended that a warning light be fitted to any automation system.

After Installation: It Is The Responsibility Of The Installer To Ensure The User:

1. Is proficient in the use of the manual emergency release mechanism.
2. Is issued with the documentation accompanying this product.
3. Understands that the gate or door may not be operated out of clear sight.
4. Ensures that children are kept clear of the gate or door area at all times, and that children do not play with the remote transmitters or any fixed trigger switches linked to the system.
5. Is instructed not to attempt to repair or adjust the automation system and to be aware of the danger of continuing to use the automation system in an unsafe condition before a service provider attends to it.
6. Is proficient in testing the unit's safety obstruction sensing system.
7. Is aware of what to check for with regards to wear and tear that may need to be attended to from time to time by the service provider.
8. Is aware that a fatigued battery may not be disposed of in the general refuse and must be handed in at a battery merchant for safe disposal. Before removing the battery from the system the household mains must be disconnected. In the case of the motor unit being removed and scrapped, the battery must be removed first.

0011014.005

TECHNICAL SPECIFICATIONS		
Model	DC BLUE ADVANCED Pico	DC BLUE ADVANCED
Primary power supply	220 – 240Vac @ 50hz	220 – 240Vac @ 50hz
Peak power consumption	100W peak @ (220 -240vac)	120W peak @ (220 -240vac)
Motor voltage	24Vdc	24Vdc
Maximum operations per day*	50 full cycles per 24hrs @ a rate of Max. 5 per hour	50 full cycles per 24hrs @ a rate of Max. 5 per hour
Traveller speed*	8m/min	8m/min
Operating temperature range	-10 to 50° C (14F to 122F)	-10 to 50° C (14F to 122F)
Anti-crushing safety sensing	Yes - Electronic digital profiling	Yes - Electronic digital profiling
Auxiliary supply output	24Vdc @ 250mA peak or 150mA continuous	24Vdc @ 250mA peak or 150mA continuous
Rated battery charging voltage	27.5Vdc	27.5Vdc
Built in receiver format	ET BLU MIX © enhanced rolling code.	ET BLU MIX © enhanced rolling code.
Receiver frequency	433.92Mhz	433.92Mhz
Memory	EEPROM	EEPROM
Applicable door types	One piece trackless tip-up or multiple panel sectional overhead single width doors	One piece trackless tip-up or multiple panel sectional overhead double width doors
Drawbar options (Ex-stock)	2.2m or 3.2m	2.2m or 3.2m or 3.7m
Applicable door sizes*	<10m ²	<15m ²

* Based on the assumption that the door is balanced correctly and moving freely.

COMPONENT IDENTIFICATION AND DESCRIPTIONS

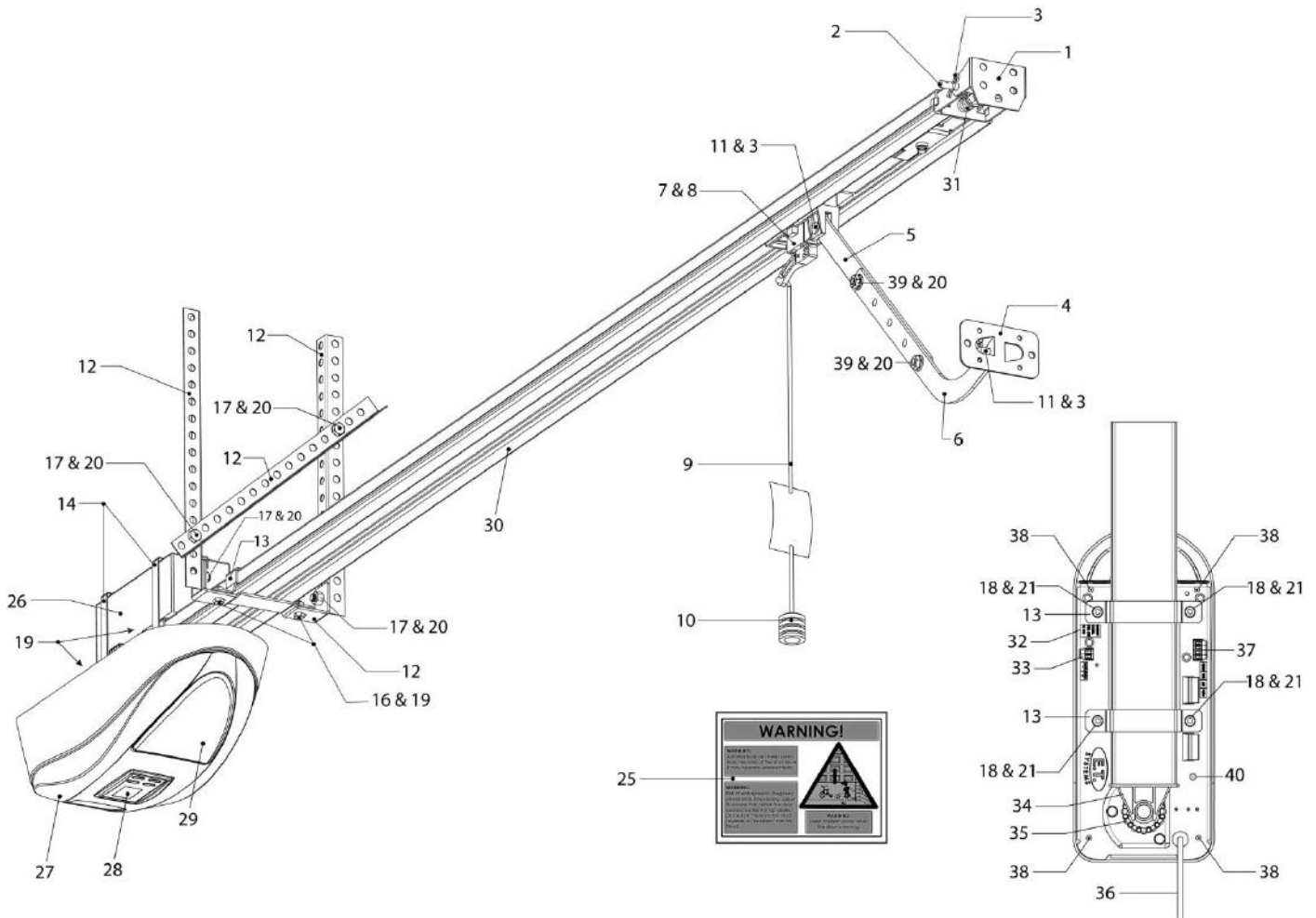

Diagram number	Description	Qty	Diagram number	Description	Qty
1	Wall mount bracket	1	21	Flat washers M6	6
2	Pivot pin 8mm x 90mm	1	22	Coach screws 8 x 60mm	2
3	Cotter pins 1.8mm x 35mm	3	23	Coach screws 8 x 40mm	6
4	Door mount bracket	1	24	Wall plugs 10mm	2
5	Straight link arm	1	25	Warning sticker	1
6	Curved link arm extension	1	26	24Vdc 3.5A/h Battery (Optional extra)	1
7	Emergency release assembly	1	27	Motor-head	1
8	Round head machine screws M6 x 20mm	4	28	Control panel dashboard	1
9	Emergency release cord 1.1m with warning tag	1	29	Courtesy light diffuser lens	1
10	Emergency release cord plastic knob/handle	1	30	Drawbar	1
11	Pivot pins 8mm x 25mm	2	31	Drawbar spring dampener and shock absorber	1
12	Hanging strap drawbar attachment bracket	1	32	Battery connection beneath dust cover sticker	1
13	Drawbar brackets	3	33	E-Coms connection plug with dust cover	1
14	Battery straps	2	34	Drawbar back-end	1
15	Hanging straps 1m	2	35	Splined sprocket with chain	1
16	Machine bolts 10mm head M6 x 16mm	2	36	Household mains cord 1.5m	1
17	Machine bolts 14mm head M8 x 16mm	6	37	Auxiliaries connection plug with dust cover	1
18	Machine nuts M6	4	38	Cover screws	4
19	Nylock nuts M6	6	39	Machine bolts 14mm head M8 x 20mm	2
20	Nylock nuts M8	8	40	220Vac mains protection fuse	1

HARDWARE INSTALLATION

INSTALLING THE MANUAL OVERRIDE CLUTCH ASSEMBLY ONTO THE SLEDGE/TRAVELLER

(See page 5 for component identification)

The diagrams below show how to install the manual override clutch assembly onto the sledge traveller. Ensure the 4 machine screws are securely fastened. Do this prior to installing the drawbar.

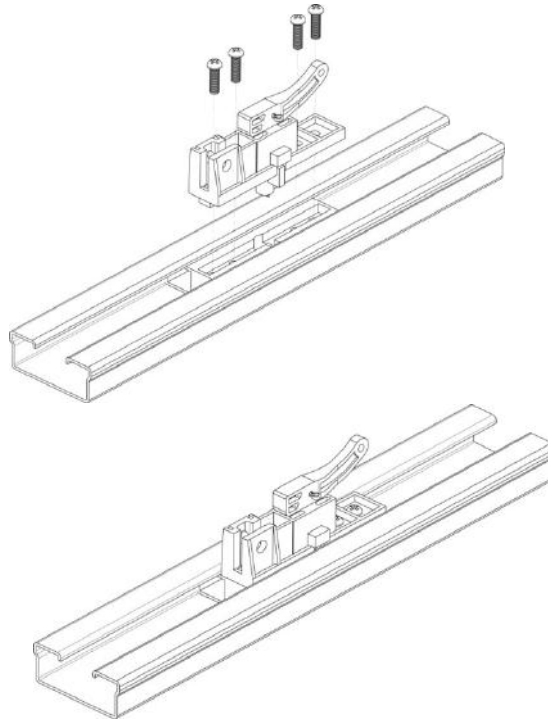

! CAUTION

TO DISENGAGE AND MOVE DOOR MANUALLY:

Warning! Door may plummet closed when released.
While pulling the emergency release cord downward, move the door open or closed by hand.

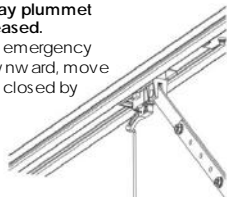

TO RE-ENGAGE AND LOCK DOOR BACK ONTO DRIVE:

Let the cord go and move door open or closed until the sledge/traveller locks back onto the chain drive.



Install the manual override label as shown here.

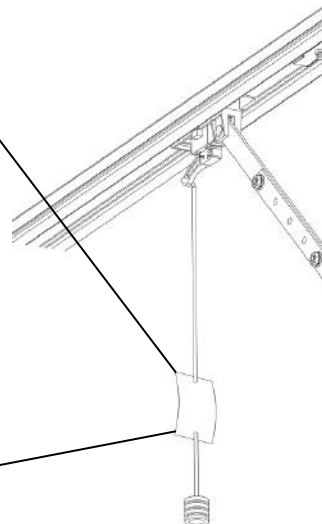

HARDWARE INSTALLATION

Standard Single Track or Double Track Sectional Garage Door Method

INSTALLING THE WALL MOUNT BRACKET (See page 5 for component identification)

The diagram below shows how to determine the mounting height and position of the wall mount bracket, in the case of a standard single track or double track overhead sectional garage door system.

NB!!! The wall mount bracket is one of the components that take the majority of the load in a garage door automation system. Extra care needs to be taken to ensure the bracket is securely fastened and that whatever the bracket is fastened to, can withstand force equal to the force of the door when the spring balancing of the door is removed (snapped)

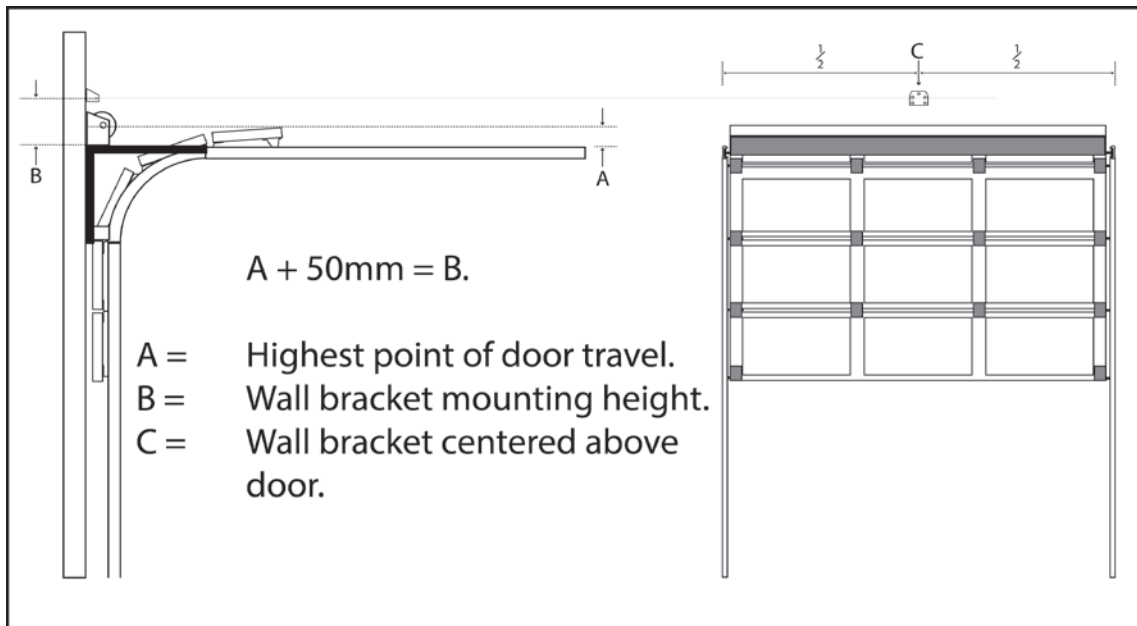

INSTALLING THE DRAWBAR AND HANGING STRAPS (See page 5 for component identification)

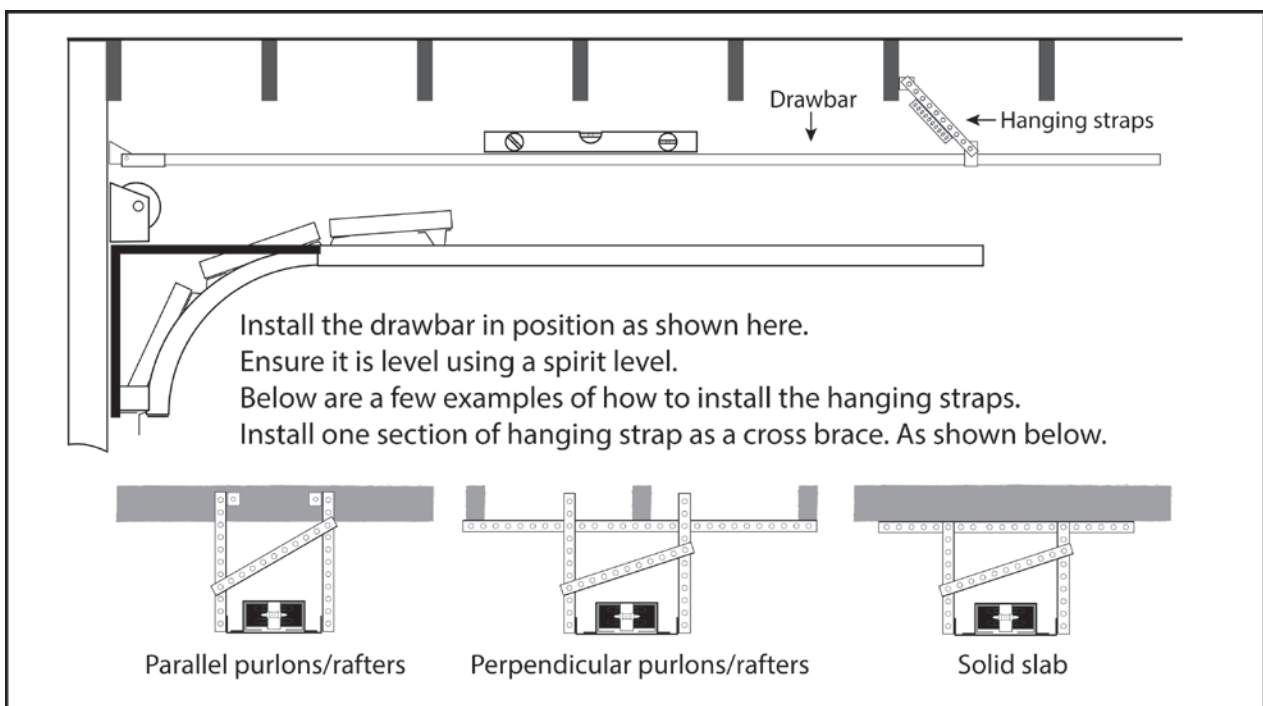

INSTALLING THE DOOR MOUNT BRACKET (See page 5 for component identification)

Mount the door mount bracket on the inside fascia of the door as shown below. Keep it as in line as possible with the top guide rollers and centred from side to side of the door.

NB!!! The door mount bracket is one of the components that will take the majority of the load in a garage door automation system. Extra care needs to be taken to ensure that the bracket is securely fastened. Whatever the bracket is fastened to, must also withstand a force equal to the force of the door when the spring balancing of the door is removed. For example if a balancing spring snaps.

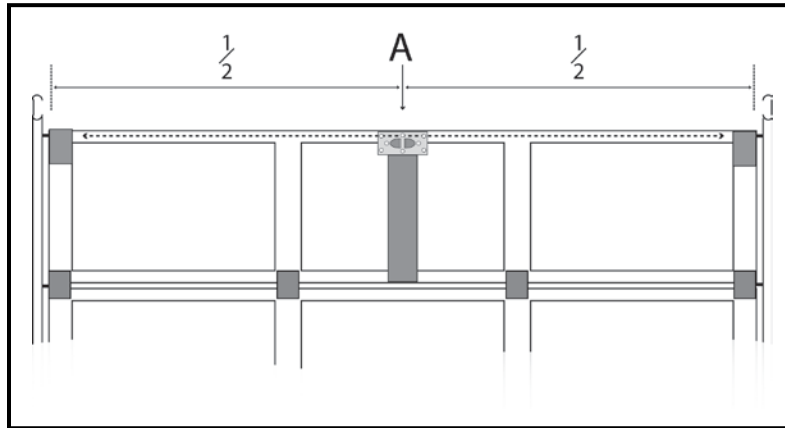
**INSTALLING THE LINK ARM** (See page 5 for component identification)

Close the door fully. Install the curved link arm extension in the door mount bracket using one of the cotter pins and 25mm long pivot pins supplied. Next using the other 25mm long pivot pin and cotter pin, install the straight link arm in the traveller/sledge that has been moved all the way to the front of the drawbar. Finally bolt the curved extension to the straight link arm, so that the two combined form the same angle as shown below.

This method provides better positive locking of the door in the closed position than the commonly used 45° angled link arm. This method also produces less backward force on the gearbox when trying to compress the seal at the bottom of the door as the downward force is generated by the link arm camming up and over the door.

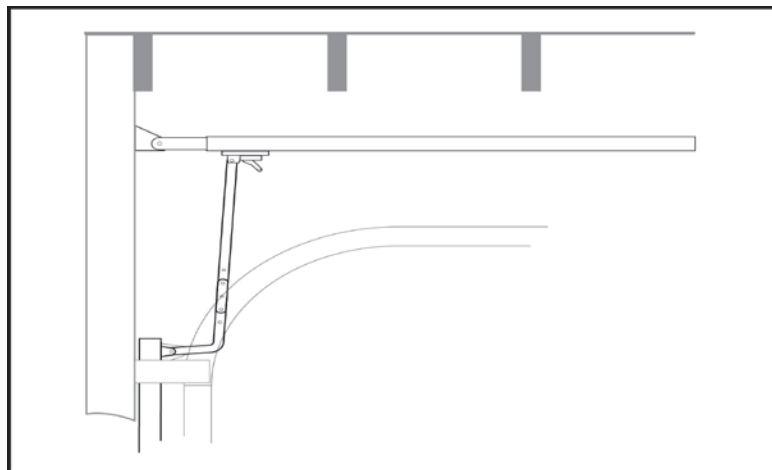
**TESTING THE MECHANICAL DRIVE AND LINKAGE**

It is now possible to test the mechanical movement of the door with the link arm attached and the sledge/traveller engaged onto the chain drive. The movement of the door throughout its travel should be approximately the same while pulling the chain around the drawbar, as it is when the chain is not engaged.

If satisfied that the drawbar is not causing unnecessary drag or hindrance to the door movement, then go ahead and attach the motor-head to the drawbar. (Page 11)

HARDWARE INSTALLATION

Trackless tip-up door

INSTALLING THE WALL MOUNT BRACKET (See page 5 for component identification)

From the top edge of the door in the closed position, measure 275 – 300mm perpendicular to the top edge of the door. Install the wall mount bracket at this height where it is positioned above the centre of the door as shown in the diagram below.

NB!!! The wall mount bracket is one of the components that will take the majority of the load in a garage door automation system. Extra care needs to be taken to ensure that the bracket is securely fastened. Whatever the bracket is fastened to, must also withstand a force equal to the force of the door when the spring balancing of the door is removed. For example if a balancing spring snaps.

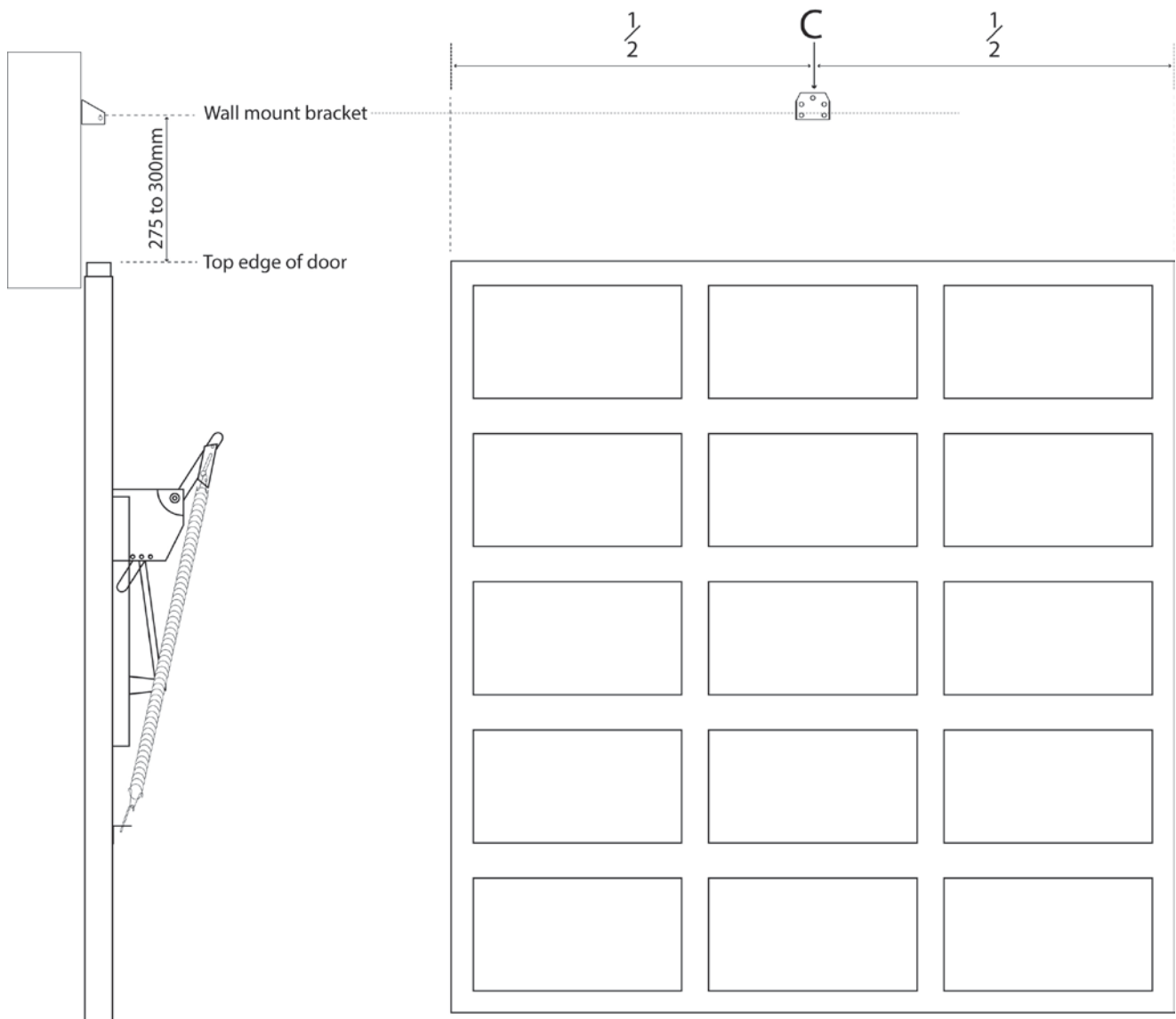

INSTALLING THE DOOR MOUNT BRACKET (See page 5 for component identification)

Mount the door mount bracket on the top edge of the door, where it is centred from side to side of the door.

NB!!! The door mount bracket is one of the components that will take the majority of the load in a garage door automation system. Extra care needs to be taken to ensure that the bracket is securely fastened. Whatever the bracket is fastened to, must also withstand a force equal to the force of the door when the spring balancing of the door is removed. For example if a balancing spring snaps.

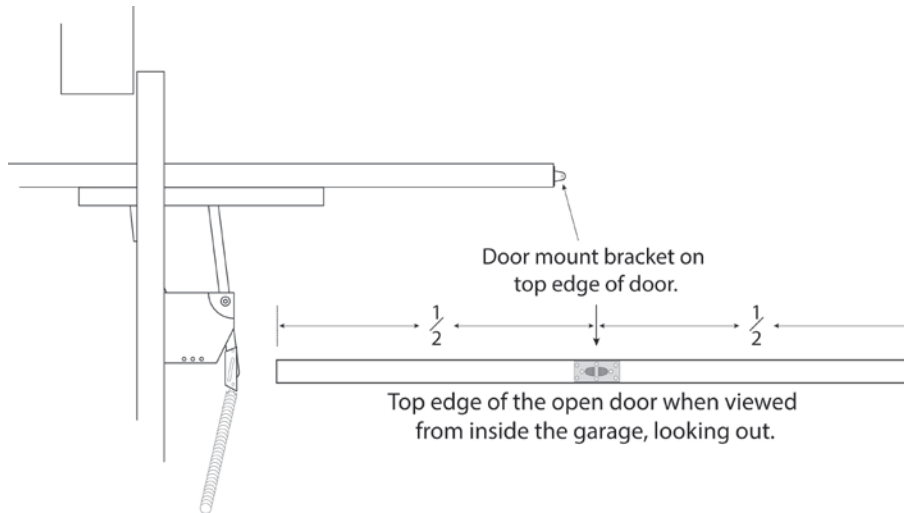
**INSTALLING THE LINK ARM AND HANGING STRAPS** (See page 5 for component identification)

Install the front end of the drawbar in the wall mount bracket using the 90mm pivot pin and one of the cotter pins. Raise the drawbar up and out of the way of the door. Install the link arm into both the sledge/traveller and door mount bracket using the 25mm pivot pins and remaining two cotter pins. Prepare and install the hanging straps so that when the door is in the full open position, the link arm lays 180° to the door. Do not use the curved link arm extension in this type of installation. The diagram below shows the final position of the drawbar when installed and examples of how to prepare the hanging straps.

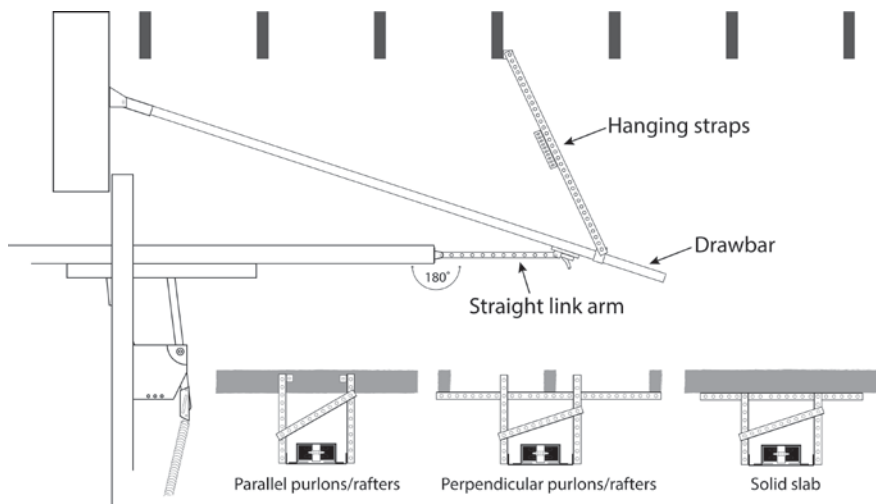
**TESTING THE MECHANICAL DRIVE AND LINKAGE**

It is now possible to test the mechanical movement of the door with the link arm attached and the sledge/traveller engaged onto the chain drive. The movement of the door throughout its travel should be approximately the same while pulling the chain around the drawbar, as it is when the chain is not engaged.

If satisfied that the drawbar is not causing unnecessary drag or hindrance to the door movement, then go ahead and attach the motor-head to the drawbar. (Page 11)

ATTACHING THE MOTOR-HEAD TO THE DRAWBAR (See page 5 for component identification)

Insert the splined motor drive shaft into the splined sprocket at the back-end of the drawbar. Swivel the motor-head around so that the motor mounting straps are able to fit over the drawbar and onto the mounting studs on the motor-head. Fasten the drawbar mounting straps onto the motor-head using the 4 M6 machine nuts and M6 flat washers.

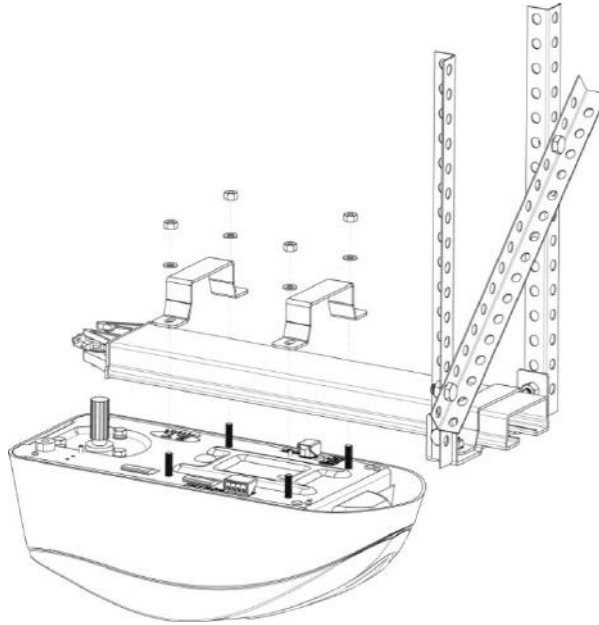
**ATTACHING THE BATTERY TO THE DRAWBAR** (See page 5 for component identification)

Making use of the extended length mounting straps and 4 of the M6 Nylock nuts fasten the battery atop the drawbar as shown below. Remove the sticker covering the battery plug socket on the motor-head and insert the battery lead plug. The battery plug is moulded in such a way as to only be inserted in one direction. Ensure the plug is in firmly.

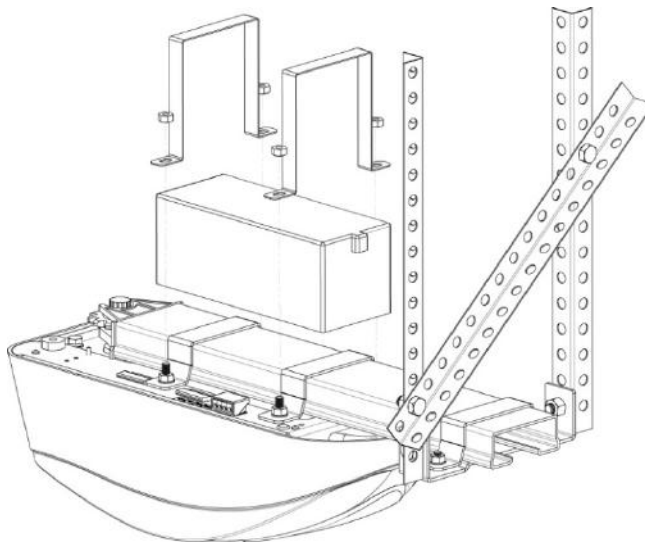
**SUPPLYING HOUSEHOLD POWER TO THE MOTOR-HEAD**

The DC BLUE ADVANCED © comes supplied with an IEC and SANS compliant 220Vac power cord, 1,5m in length. Plug the sealed non-serviceable 3 pin 15Amp plug into a certified 15Amp plug socket that is installed outside of the workings of the garage door system, yet still within reach of the power cord. Ensure there is no strain on the cord once installed. Also ensure that nothing will catch or snag the power cord when the garage door is moving or when people or cars pass below the system.

OPTIONAL EXTRA DEVICES WIRING CONNECTIONS

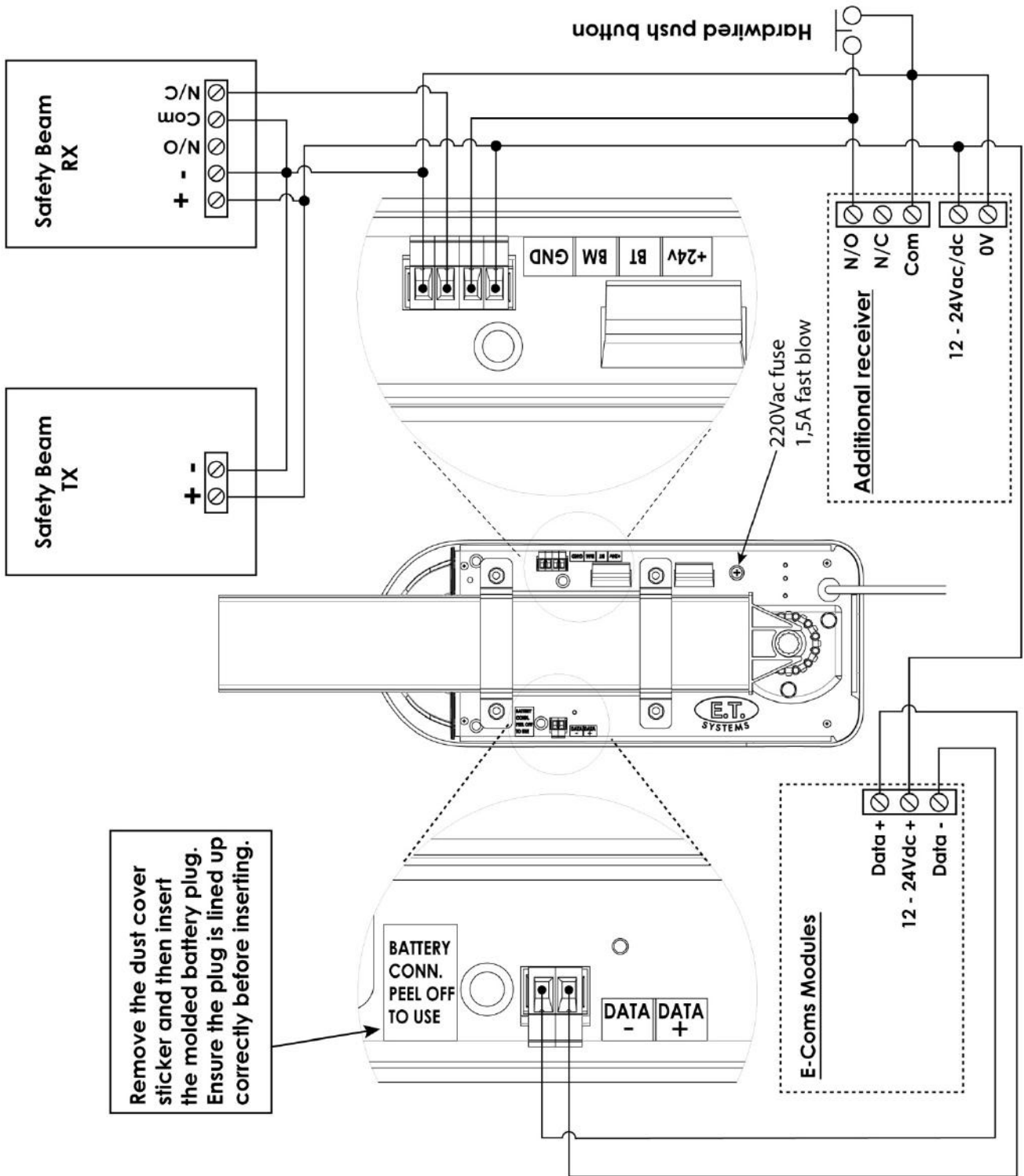

Remove the dust cover sticker and then insert the molded battery plug. Ensure the plug is lined up correctly before inserting.

CONTROL PANEL DASHBOARD AND PROGRAMMING MENU SUMMARY

(How to navigate the menu options)

Control panel dashboard

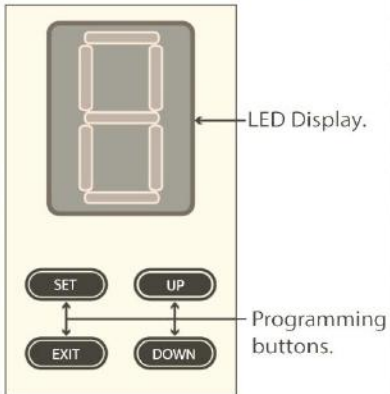

NOTE! Before attempting to execute the instructions, read the complete instruction table, for a setup option. Some steps require a response before a safety timeout expires and you may still be reading the next step when the timeout expires.

- To enter the **Programming menu** from Standby mode, **press and hold** the **“SET”** button until the **buzzer beeps twice**.
- Once in the Programming menu, use the up and down buttons to scroll between options.
- For further instruction on changing settings, refer to the instruction tables on the page indicated for each option.

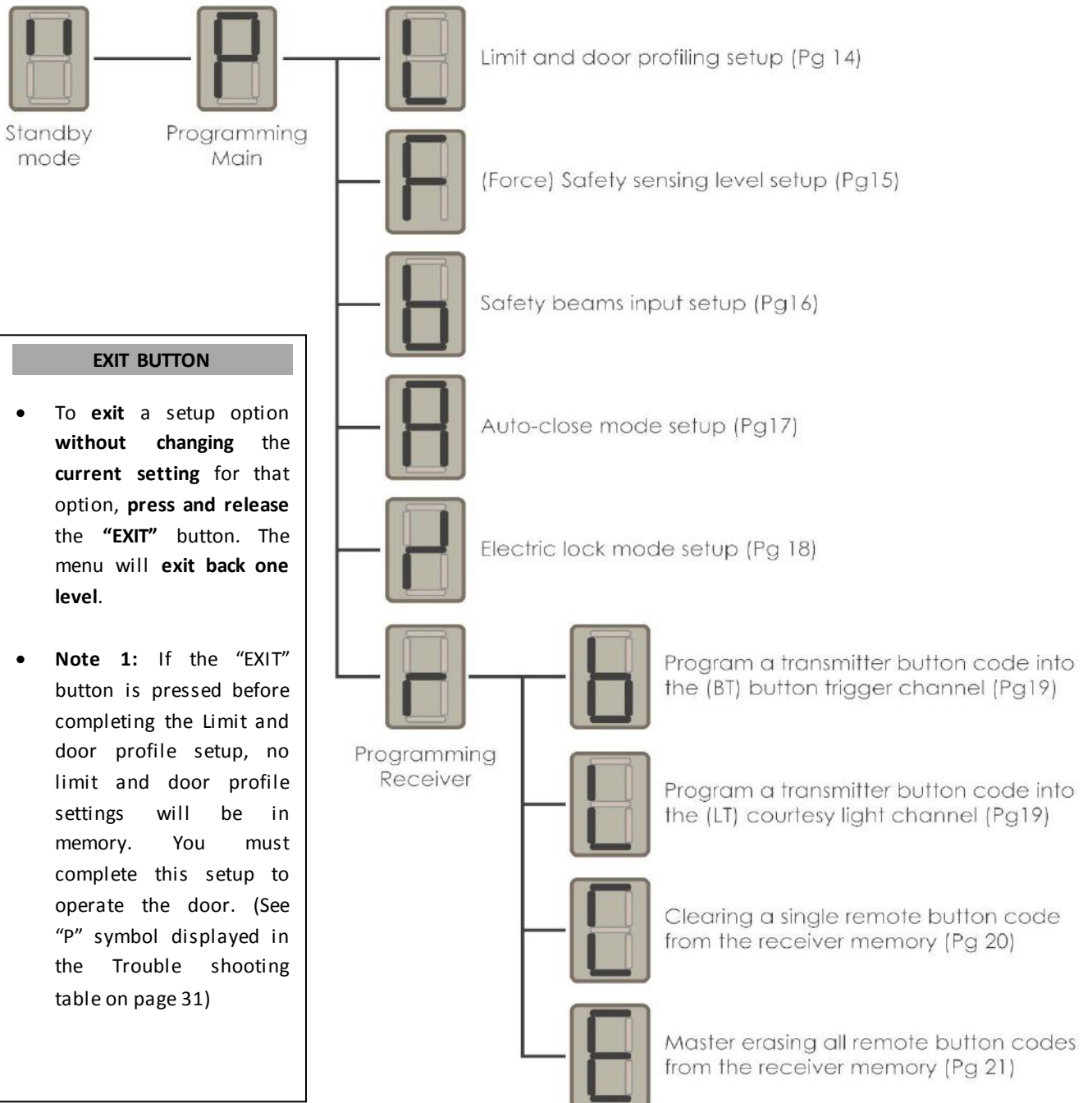

EXIT BUTTON



























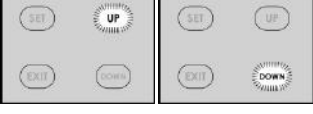

- To **exit** a setup option **without changing** the **current setting** for that option, **press and release** the **“EXIT”** button. The menu will **exit back one level**.
- **Note 1:** If the **“EXIT”** button is pressed before completing the Limit and door profile setup, no limit and door profile settings will be in memory. You must complete this setup to operate the door. (See **“P”** symbol displayed in the Trouble shooting table on page 31)







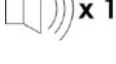





PROGRAMMING

Open and closed limit position setup and door load profiling.

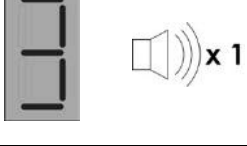
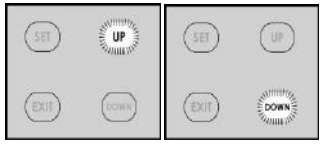
From Standby Mode



Action		Response	
To enter the program menu. Press and hold SET button until buzzer beeps twice.		Display begins flashing "P" and buzzer beeps twice to confirm the main program menu is active.	 
Scroll up with the UP button until "L" flashes.		Display flashes "L" to confirm limit setup mode is selected.	
Press and release SET button to begin limit setup.		Buzzer beeps once and "O" displays to indicate open limit position must be set.	 
Press and hold the UP button to raise the door to the required open position.		The "n" symbol displays as the door opens.	
Fine tune using the UP and DOWN buttons.		The "n" and "u" symbols confirm the door direction while fine tuning.	 or 
When satisfied the door is in the correct open position, press the SET button to advance to the close limit setup.		The buzzer beeps once and the "C" symbol displays to indicate the closed limit position must be set.	 
Press and hold the DOWN button to lower the door to the required closed position.		The "u" symbol displays as the door closes.	
Fine tune using the UP and DOWN buttons.		The "n" and "u" symbols confirm the door direction while fine tuning.	 or 
When satisfied the door is in the correct closed position, press the SET button to advance to the automatic door load profiling stage.		Door opens and closes again. The display confirms the direction and the buzzer will beep intermittently as the motor runs. When complete, the control returns to the main program menu. Display = Flashing "P" and buzzer beeps once.	     
Scroll up or down to next program option.		OR	Press and release EXIT to return to Standby mode. See Note 1 on page 13!!! 

SETTING THE OBSTRUCTION FORCE SENSING, SAFETY LEVEL.			
Default level - 3			
From Standby Mode			
Action		Response	
To enter the Program menu. Press and hold SET button until buzzer beeps twice.		Display begins flashing "P" and buzzer beeps twice to confirm the main program menu is active.	
Scroll up with the UP button until "F" flashes.		Display flashes "F" to confirm safety force setup mode is selected.	
Press and release SET button to enter safety force setup.		Buzzer beeps once and current safety force level is displayed. (1-9)	
Press and release the UP or DOWN buttons to scroll to the desired safety force level. (1-9)		1 = most sensitive to resistance in movement of the door. 9 = least sensitive to resistance in movement of the door.	
Press and release the SET button to save the new setting to memory and exit back to the main program menu.		The buzzer beeps once and the display returns to flashing "P".	
Scroll up or down to next program option.		OR	Press and release EXIT to return to Standby mode. 

SAFETY OBSTRUCTION SENSING IN ACTION:

In the case of the door being resisted physically or obstructed while opening.

- The motor will stop running,
- The buzzer will beep once and operator reverts to standby mode.
- On the next BT button trigger the motor will start closing the door.

In the case of the door being resisted physically or obstructed while closing.

- The motor will stop running,
- The buzzer will beep once as the motor immediately begins opening the door once again.
- On reaching the open position the operator reverts to standby mode.
- On the next BT button trigger the motor will begin the door closing.

ACTIVATING SAFETY BEAM MODE.

Default – Off (Disabled)

NB! When auto-close mode is activated, the safety beam mode automatically becomes active.

This is mandatory as auto-close mode may never be used without a set of safety beams installed.

With auto-close active, safety beam setup mode is no longer available in the setup menu.

From Standby Mode



Action		Response	
To enter the Program menu. Press and hold SET button until buzzer beeps twice.		Display begins flashing "P" and buzzer beeps twice to confirm the main program menu is active.	
Select safety beams setup by scrolling up with the UP button until "b" flashes.		Display flashes "b" to confirm safety beam setup mode is selected.	
Press and release SET button to enter safety beam setup.		Buzzer beeps once and current beam status is displayed. 0 = Off and 1 = On	
Press and release the UP button for On or DOWN button for Off selection.		0 = Off (Disabled) 1 = On (Active)	OR
Press and release the SET button to save the new setting to memory and exit back to the main program menu.		The buzzer beeps once and the display returns to flashing "P".	
Scroll up or down to next program option.		OR Press and release EXIT to return to Standby mode.	

ACTIVATING THE AUTO-CLOSE MODE AND SELECTING AN AUTO-CLOSE TIME.

Default – Off

NB! When auto-close mode is activated, the safety beam mode automatically becomes active.

This is mandatory as auto-close mode may never be used without a set of safety beams installed.

With auto-close active, safety beam setup mode is no longer available in the setup menu.

From Standby Mode



Action		Response	
To enter the Program menu. Press and hold SET button until buzzer beeps twice.		Display begins flashing "P" and buzzer beeps twice to confirm the main program menu is active.	
Select auto-close setup by scrolling up with the UP button until "A" flashes.		Display flashes "A" to confirm auto-close setup mode is selected.	
Press and release SET button to enter auto-close setup.		Buzzer beeps once and current auto-close status is displayed.	
Press and release the UP or DOWN buttons to scroll to the desired setting.		0 = Off. 5 = 50 sec. 1 = 10sec. 6 = 60sec. 2 = 20sec. 7 = 70sec. 3 = 30sec. 8 = 80sec. 4 = 40sec. 9 = 90sec.	To
Press and release the SET button to save the new setting to memory and exit back to the main program menu.		The buzzer beeps once and the display returns to flashing "P".	
Scroll up or down to next program option.		OR Press and release EXIT to return to Standby mode.	

SELECTING A LOCK MODE.

Default – Off

NB!! The “E-Coms” output on the control card is designated to be used with an “E-Coms” Relay module, when using any electric lock. These modules are only available via ET Systems.

For further instructions on the E-Coms relay module, consult the instructions included with it.

For assistance the product support department can be contacted on:
0861 109 9238 or support@et.co.za

In **strike lock mode**, the lock relay will energise 0.5sec before the motor begins opening and release again 0.5sec after the motor has begun moving. (Total 1sec. pulse length)

In **magnetic lock mode**, the lock relay will energise, 0.5sec before the motor starts opening and remain energised until the door is closed again.

From Standby Mode



Action		Response	
To enter the Program menu. Press and hold SET button until buzzer beeps twice.		Display begins flashing “P” and buzzer beeps twice to confirm the main program menu is active.	
Select lock setup by scrolling up with the UP button until “/” flashes.		Display flashes “/” to confirm lock setup mode is selected.	
Press and release SET button to enter lock setup.		Buzzer beeps once and current lock status is displayed.	
Press and release the UP or DOWN buttons to scroll to the desired setting.		0 = Off. 1 = Strike lock. 2 = Magnetic lock.	
Press and release the SET button to save the new setting to memory and exit back to the main program menu.		The buzzer beeps once and the display returns to flashing “P”.	













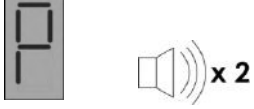

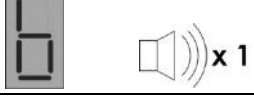

Scroll up or down to next program option.

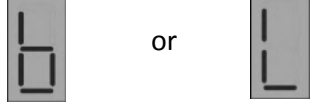

OR

Press and release EXIT to return to Standby mode.

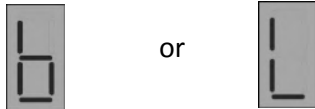

LEARNING A TRANSMITTER CODE IN THE RECEIVER MEMORY. Max users (BT) button trigger channel = 35 user codes Max users (LT) courtesy light trigger channel = 5 user codes			
NB!! The built in receiver will only work with the ET BLU MIX © enhanced rolling code or ET BLUE rolling code transmitters.			
From Standby Mode			
Action		Response	
To enter the Program menu. Press and hold SET button until buzzer beeps twice.		Display begins flashing "P" and buzzer beeps twice to confirm the main program menu is active.	
Select receiver setup by scrolling up with the UP button until "r" flashes.		Display flashes "r" to confirm receiver programming menu is selected.	
Press and release SET button to enter receiver programming.		Buzzer beeps once and "b" for (BT) is displayed.	
Press and release the UP or DOWN buttons to scroll to the channel the remote button must be learnt into.		b = (BT) button trigger channel. L = (LT) Courtesy light trigger channel.	
1. Press and hold desired remote button.		LED on remote transmitter illuminates.	
2. While still holding the desired remote button , press and release the "SET" button.		<p>"1" on display and 1 beep = user code successfully learnt.</p> <p>"2" on display and 2 beeps = user code already in the receiver memory.</p> <p>"3" on display and 3 beeps = Unsuccessful because no code was seen within 4 sec of the SET button being pressed. Mandatory timeout.</p> <p>"F" on display and multiple rapid beeps = Memory full</p>	<p> Successful</p> <p> Code already in memory</p> <p> Unsuccessful</p> <p> Memory full</p>
		The display returns to whichever channel was previously selected. "b" or "L"	
3. Release the remote button			
Program another remote button code into that channel, by repeating 1, 2 & 3 above	OR	Scroll up or down to the next receiver program option.	Press and release EXIT to return to receiver setup menu.
			











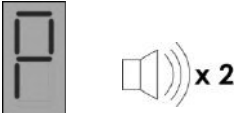

CLEARING A SINGLE TRANSMITTER BUTTON CODE FROM THE RECEIVER MEMORY.

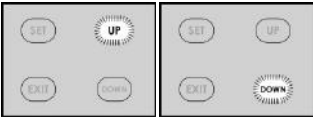
This can only be completed if the remote control that must be erased is present.

If the remote control that must be removed is missing or unobtainable, then a master erase procedure (Page 21) must be performed and the remaining, valid user codes must all be learnt into the memory once again.

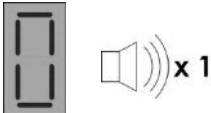
From Standby Mode



Action		Response	
To enter the Program menu. Press and hold SET button until buzzer beeps twice.		Display begins flashing "P" and buzzer beeps twice to confirm the main program menu is active.	
Select receiver setup by scrolling up with the UP button until "r" flashes.		Display flashes "r" to confirm receiver setup mode is selected.	
Press and release SET button to enter receiver setup.		Buzzer beeps once and "b" is displayed.	
Press and release the UP or DOWN buttons to scroll to the "C" option.		"C" is displayed.	
Press and hold desired remote button to be erased.		LED on remote transmitter illuminates.	
While still holding the desired button, press and release SET button.		<p>"0" on display and 1 beep = user code successfully erased.</p> <p>"3" on display and 3 beeps = Unsuccessful because no code was seen within 4 sec of the SET button being pressed. Mandatory timeout.</p>	 
Release the remote button			
		Display reverts back to flashing "r" to indicate you have returned to the receiver setup menu.	
Scroll up or down to next program option.		OR	Press and release EXIT to return to Standby mode. 

MASTER ERASING ALL TRANSMITTER BUTTON CODES FROM THE MEMORY.

From Standby Mode











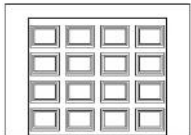

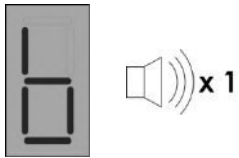
Action		Response	
To enter the Program menu. Press and hold SET button until buzzer beeps twice.		Display begins flashing "P" and buzzer beeps twice to confirm the main program menu is active.	
Select receiver setup by scrolling up with the UP button until "r" flashes.		Display flashes "r" to confirm receiver setup mode is selected.	
Press and release SET button to enter receiver setup.		Buzzer beeps once and "b" is displayed.	
Press and release the UP button to scroll to the "E" option.		"E" is displayed.	
Press and hold SET button and do not release.			
While still holding the SET button. Press and release UP button to start master erase. Release both buttons once beeps begin.		Display flashes "E" and buzzer beeps intermittently to warn that master erase is about to begin. NB! Pressing and holding EXIT at this point will abort the master erase.	
Master erase routine is running. Wait.		Display goes blank and buzzer silences to indicate erase has commenced.	
Master erase routine is running. Continue waiting.		Display stays "0" and buzzer emits 1 long beep, to indicate Master erase is complete.	
		Display reverts back to flashing "r" to indicate you have returned to the receiver setup up menu.	
Scroll up or down to next program option.		OR Press and release EXIT to return to Standby mode.	

A QUICK METHOD OF LEARNING A TRANSMITTER BUTTON CODE INTO THE RECEIVER MEMORY WITHOUT ENTERING THE PROGRAMMING MENU.

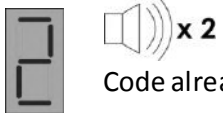
Max users (BT) button trigger channel = 35 user codes





NB!! No remote codes can be learnt into the (LT) courtesy light channel this way.

Action		Response	
Door must be closed		Door closed	
Press and hold the "Up" button until buzzer beeps and display shows "b".		Buzzer beeps once and display shows "b"	
Press and hold required remote button.		LED on remote transmitter remains lit.	
Press and release the "SET" button.		<p>"1" on display and 1 beep = user code successfully registered.</p> <p>"2" on display and 2 beeps = user code already in the receiver memory.</p> <p>"3" on display and 3 beeps = Unsuccessful because no code was seen within 4 sec of the "SET" button being pressed. Mandatory timeout.</p> <p>"F" on display and multiple rapid beeps = Memory full</p>	<p> Successful</p> <p> Code already in memory</p> <p> Unsuccessful</p> <p> Memory full</p>
Release both the remote button and "SET" button			
		Display reverts back standby mode "11"	

BASIC OPERATING FEATURES

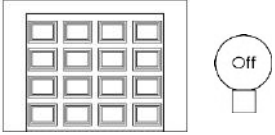
Basic open and close triggers using the (BT) button trigger.

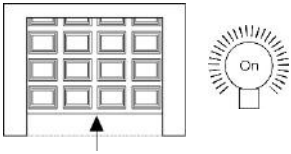

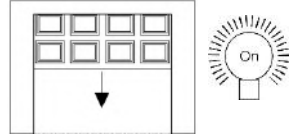
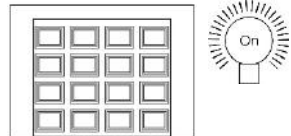



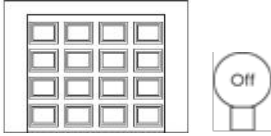

Example 1. Simply opening the door fully and closing the door again fully.

Action		Response	
		Door in the closed position. Courtesy light off.	
Press and release either the remote button trigger or the hardwired trigger.		Door begins opening and courtesy light switches on.	
Wait for door to reach the full open position.		Door stops and waits in the open position. Courtesy light remains on for a further 3 minutes.	
Press and release either the remote button trigger or the hardwired trigger.		Door begins closing and if the courtesy light had previously timed out and switched off, it will switch on again for three minutes.	
Wait for door to reach the closed position.		Door stops in the closed position. Light remains on until three minute timer has expired.	

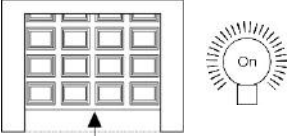
BASIC OPERATING FEATURES

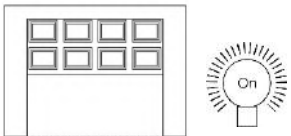
Basic open and close triggers using the (BT) button trigger.

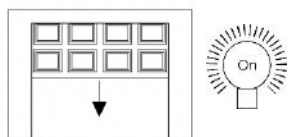
Example 2. Using the (BT) button trigger input while the door is running.

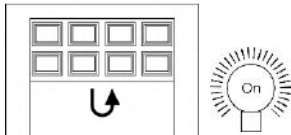







Action		Response	
		Door in the closed position. Courtesy light off.	
Press and release either the remote button trigger or the hardwired trigger.		Door begins opening and courtesy light switches on.	
Press and release either the remote button trigger or the hardwired trigger, before the door reaches the full open position		Door stops and waits for next instruction. Courtesy light remains on for a further 3 minutes.	
Press and release either the remote button trigger or the hardwired trigger.		Door begins closing and if the courtesy light had previously timed out and switched off, it will switch on again for three minutes.	
Press and release either the remote button trigger or the hardwired trigger, while the door is still closing.		Door stops and begins opening once again. Light remains on until three minute timer has expired.	

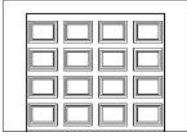

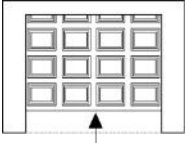
ADVANCED OPERATING FEATURES

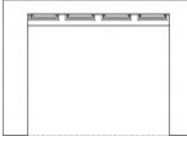



Advanced triggers using the remote (BT) button trigger

(PARTY MODE)

Example 3. Using the remote (BT) button trigger to disable any closing triggers

Action		Response	
TO ACTIVATE			
		Door in the closed position. Courtesy light off.	 
Press and release either the remote button trigger or the hardwired trigger.		Door begins opening and courtesy light switches on.	 
Stop door while opening or simply wait until it reaches the open position.		Door stops and waits at the required open position. Courtesy light remains on for a further 3 minutes.	 
Press and hold the remote button trigger, +/- 10 seconds, until buzzer beeps.		Buzzer beeps rapidly to indicate party mode is active.	 on/off..... Rapid

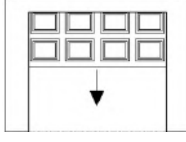
TO CONFIRM			
Any attempt to operate the door normally.		Buzzer repeats rapid beeps to indicate the party mode is still active. The door will not move.	 on/off..... Rapid











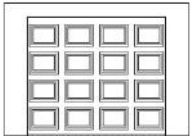







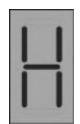





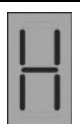

TO DE-ACTIVATE			
Press and hold the remote button trigger +/- 10 seconds, until buzzer beeps.		Buzzer beeps once and door starts closing. Courtesy light switches on for three minutes.	 x 1  

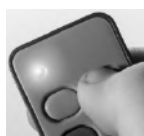
ADVANCED OPERATING FEATURES

Advanced triggers via the remote (BT) button trigger and (LT) courtesy light trigger

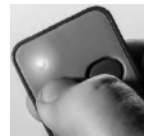
(HOLIDAY LOCK-OUT MODE)

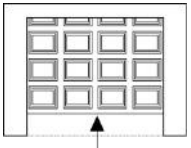
Example 4. Using the remote (BT) button trigger and (LT) courtesy light to lock out any opening triggers

Action		Response	
TO ACTIVATE			
Door must be closed		Door in the closed position. Courtesy light off.	 
Press and hold remote courtesy light button.		Courtesy light switches on.	
Release button when buzzer begins to sound. After +/- 5 seconds.		Buzzer tones for 5 seconds . Courtesy light remains on.	 
Whilst buzzer is still sounding, Press and release the remote trigger button, to activate Holiday lock-out.		Buzzer beeps, light flashes rapidly and display shows "H" to indicate Holiday lock-out is active.	 on/off..... Rapid     
TO CONFIRM			
Any attempt to operate the door normally.		Buzzer beeps, light flashes rapidly and display shows "H" to indicate Holiday lock-out is active.	 on/off..... Rapid     
TO DE-ACTIVATE			
Press and hold remote courtesy light button.		Courtesy light switches on.	
Release button when buzzer begins to sound. After +/- 5 seconds.		Buzzer tones for 5 seconds . Courtesy light remains on.	 
Whilst buzzer is still sounding, Press and release the remote trigger button, to de-activate Holiday lock-out.		Buzzer beeps once, courtesy light remains on and the door begins opening as Holiday lock-out de-activates.	  

ADVANCED OPERATING FEATURES

LOCK MODES – STRIKE LOCK MODE.



NB!! This function is only available if an ET E-Coms relay module is installed.



Action		Response	
		<p>Door in the closed position. Courtesy light off. Lock relay module off.</p>	
<p>Press and release either the remote button trigger or the hardwired trigger.</p>		<p>0.5 seconds before the door begins opening, the lock relay module and courtesy light switches on.</p>	
		<p>Door begins opening, lock relay module and courtesy light remains on.</p>	
		<p>0.5 seconds after door begins opening, the lock relay module switches off again. Door continues opening and light remains on for 3 minutes.</p>	

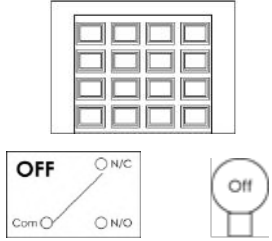

ADVANCED OPERATING FEATURES

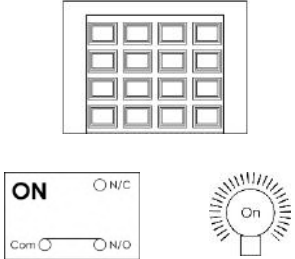
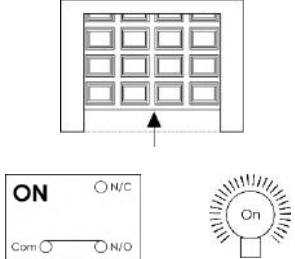
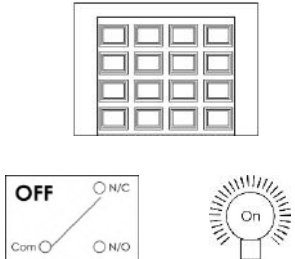
LOCK MODES – MAGNETIC LOCK MODE.

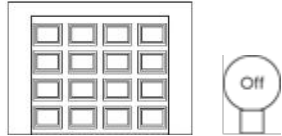
NB!! This function is only available if an ET E-Coms relay module is installed.

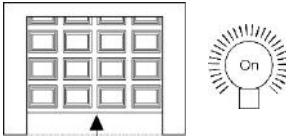
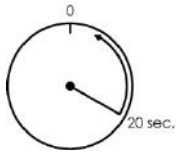
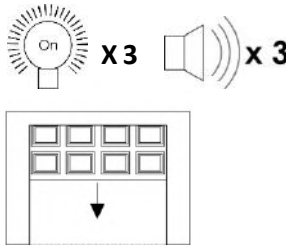
Action		Response	
		<p>Door in the closed position. Courtesy light and lock relay module, off.</p>	
<p>Press and release either the remote button trigger or the hardwired trigger.</p>		<p>0.5 seconds before the door begins opening, the lock relay module and courtesy light switches on.</p>	
		<p>Door begins opening, lock relay module and courtesy light remains on.</p>	
		<p>Lock relay module remains on until door is closed again. Courtesy light remains on for 3 minutes after last trigger.</p>	

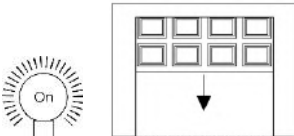
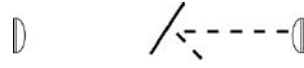
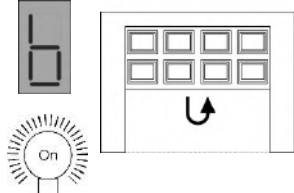
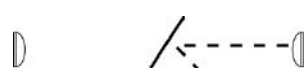
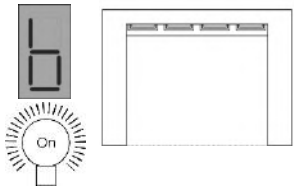
ADVANCED OPERATING FEATURES			
Auto-close feature.			
Action		Response	
		Door in the closed position. Courtesy light off.	
Press and release either the remote button trigger or the hardwired trigger.		Door begins opening and courtesy light switches on.	
On reaching the full open position, the auto-close timer times out the previously programmed auto-close time. 20 sec. for example.		Courtesy light and buzzer, flashes and sounds three times, before door begins closing automatically.	

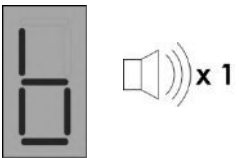





ADVANCED FEATURES			
Safety beam input			
NB!! This input only affects the closing cycle.			
Action		Response	
		Door closing. Light on.	
Interrupt the safety beams.		Display shows "b", door stops and begins opening once again. Light remains on.	
Safety beam still interrupted.		Door reaches full open position. Display continues to show "b" as long as the safety beams are interrupted. Light switches off after 3min.	
Any further closing triggers while beams are still interrupted.		Door will not close. Display continues to show "b" as long as the safety beams are interrupted and buzzer beeps once.	

ADVANCED FEATURES

Courtesy light

NB!! In the case of a household mains failure, the courtesy light does not function.

The buzzer will also emit a short beep every 15 seconds for 5 minutes after any BT transaction when the household mains power is off.

Action		Response	
Every operation of the door from any position.		Light will come on for 3 minutes and door operates.	 For 3 minutes
If the light is off and the (L) courtesy light button on the remote is pressed and released.		Light will come on for 60 minutes.	 For 60 minutes
If the light is on and the (L) courtesy light button on the remote is pressed and released.		The courtesy light simply switches off.	

WARNINGS WHEN USING A (BT) BUTTON TRIGGER FROM STANDBY MODE.			
Display	Buzzer and light	Reason	Resolve by.
		Safety beam obstructed.	Page 29
		Holiday lock-out active.	Page 26
		Open/closed limits and load profile routine incorrectly setup or exited without completing.	Page 14
		Party mode active.	Page 25
		Household mains power failure. On battery power only.	Re-connect household mains supply. To test. Check that light switches on when operating door. Page 30
		<ul style="list-style-type: none"> Motor fuse blown or, Encoder faulty or disconnected. 	<ul style="list-style-type: none"> Replace motor fuse or, Reconnect or replace encoder. <p>Press and release "EXIT" when done.</p>
		<ul style="list-style-type: none"> Regulator circuit damaged. 	<ul style="list-style-type: none"> Return control card for repair.

WARNINGS WHEN ATTEMPTING TO PROGRAM THE OPEN AND CLOSED LIMITS AND DOOR PROFILING.

Display	Buzzer and door	Reason	Resolve by
		<ul style="list-style-type: none"> Door physically jammed. 	<ul style="list-style-type: none"> Clear physical door obstruction or, <p>Press and release "EXIT" when done.</p>

WARRANTY:

1. All goods manufactured by ET NICE (Pty) Ltd carry a 12 month factory warranty from date of invoice.
2. All goods are warranted to be free of faulty components and manufacturing defects.
3. Faulty goods will be repaired or replaced at the sole discretion of ET NICE (Pty) Ltd free of charge within the warranty period.
4. This warranty is subject to the goods being returned to the premises of ET NICE (Pty) Ltd.
5. The carriage of goods is for the customer's account.
6. This warranty is only valid if the correct installation and application of goods, as laid out in the applicable documentation accompanying said goods, is adhered to.
7. All warranty claims must be accompanied by the original invoice.
8. All claims made by the end user must be directed to their respective service provider/installer.

The following conditions will disqualify this product from the warranty as laid out above. These conditions are non-negotiable.

1. Any unauthorized non-manufacturer modifications to the product or components thereof.
2. Any modification to the installation methods described in the installation instructions.
3. Any application or use of the product other than the intended use and application described in the product documentation.
4. Any application and or usage of this product outside of the technical specifications limits prescribed for it.
5. Any use of the product where the due diligence prescribed in the "Be Safe" document is not adhered to.

In particular for this product:

- The use of this product in heavy traffic applications such as office parks entrance/exits and residential complexes entrance/exits.
- The use of this product in non-weatherproof applications such as car ports.

The following items are not included in the warranty or they carry a special warranty condition of their own.

1. The battery (Limited 6 month warranty)
2. The motor brushes.
3. Damage resultant of wind and other climatic influences such as lightning strikes.
4. Damage due to high voltage surges on the household mains.
5. Damage due to infestation i.e. Ants nesting...
6. Water damage. It is the responsibility of the installer to ensure the product is installed in a location that is protected from water ingress. The ingress protection rating is specified in the accompanying documentation. Housings that require that cable entries are made by the installer do not carry an ex-factory ingress protection rating as it is the responsibility of the installer to seal the cable entry points after installation of the cabling.